



CABINET HARDWARE

Fanxin Hardware Co., Ltd.

Cabinet Handles & Furniture Hardware Manufacturer

FAXIONE

No.80259



Knob

A



Pulls

B



D



C



E



F



G



H



I



J



K



L



Appliance Pulls

M



N



A 80250
2-1/10in (50mm) CTC
88285
1in(28mm) CTC

B 80259
3-1/4in (76mm) CTC

C 80259
3-1/2in (82mm) CTC

D 80259
3-4/5in (89mm) CTC

E 80259
4-1/10in (96mm) CTC

F 80259
4-3/10in (102mm) CTC

G 80259
5-2/5in (128mm) CTC

H 80259
6-1/2in (152mm) CTC

I 80259
8-1/5in (192mm) CTC

J 80259
8-3/5in (203mm) CTC

K 80259
10-9/10in (256mm) CTC

L 80259
13in (305mm) CTC

M 80259
Appliance Pull 12in (305mm)CTC

N 80259
Appliance Pull 18in (457mm)CTC

FINISH SHOW

CP



BLK



NP



SN



FAXIONE

No.80219



Knob



Pulls

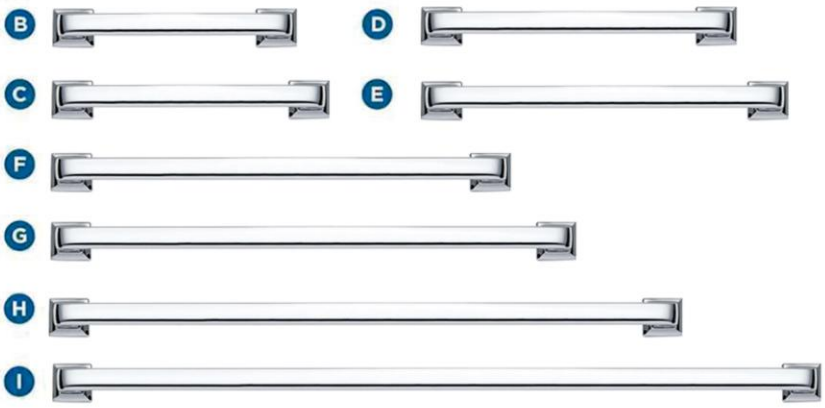

Appliance Pulls



- A** 80282
1-1/10in(28mm)CTC
- B** 80219
3in (76mm) CTC
- C** 80219
3-3/4in (96mm) CTC
- D** 80219
5in (128mm) CTC
- E** 80219
6.2in (160mm) CTC
- F** 80219
7.5in (192mm) CTC
- G** 80219
8.8in (224mm) CTC
- H** 80219
12in (305mm) CTC
- I** 80219
12.5in (320mm) CTC
- J** 80219
Appliance Pull 12in (305mm)CTC
- K** 80219
Appliance Pull 18in (457mm)CTC

FINISH SHOW

CB



BLK



NP



SN



FAXIONE

No.80266



Knob

A



Pulls

B



D



C



E



F



G



H



I



J



Appliance Pulls

K



L

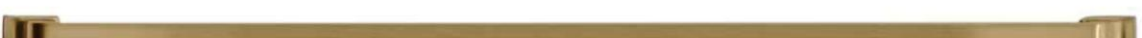

A 80272

1in(25mm) CTC

B 80266

3in (76mm) CTC

C 80266

3-4/5in (96mm) CTC

D 80266

5-1/10in (128mm) CTC

E 80266

6-2/5in (160mm) CTC

F 80266

7-3/5in (192mm) CTC

G 80266

8-9/10in (224mm) CTC

H 80266

10-1/5in (256mm) CTC

I 80266

12-1/5in (305mm) CTC

J 80266

12-4/5in (320mm) CTC

K 80266

Appliance Pull 12in (305mm)CTC

L 80266

Appliance Pull 18in (457mm)CTC

FINISH SHOW

CP



BLK



SN



BAC



FAXIONE

No.80213



- A** 80113
1-1/4 (30mm) CTC
- B** 80213
3-1/10in (76mm) CTC
- C** 80213
4in (96mm) CTC
- D** 80213
5-3/10in (128mm) CTC
- E** 80213
6-3/5in (160mm) CTC
- F** 80213
7-9/10in (192mm) CTC
- G** 80213
9-3/10in (224mm) CTC
- H** 80213
10-3/5in (256mm) CTC
- I** 80213
12-7/10in (305mm) CTC
- J** 80213
13-3/10in (320mm) CTC
- K** 80213
Appliance Pull 12in (305mm)CTC
- L** 80213
Appliance Pull 18in (457mm)CTC

Knob



Pulls

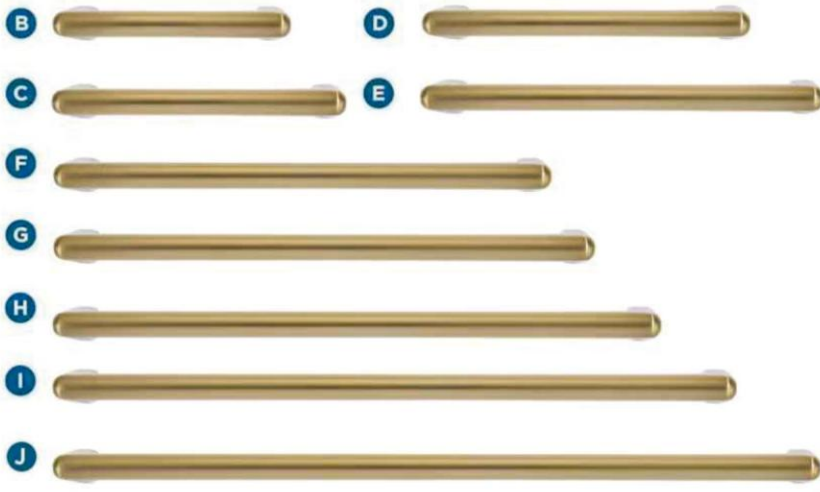

Appliance Pulls



FINISH SHOW

- AC
- AB
- NP
- CP

FAXIONE

No.80265



Pendant



Pulls

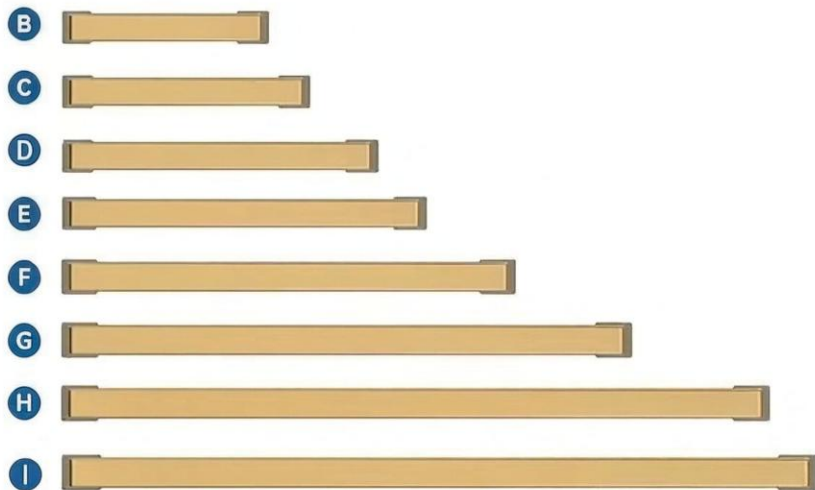

Appliance Pulls

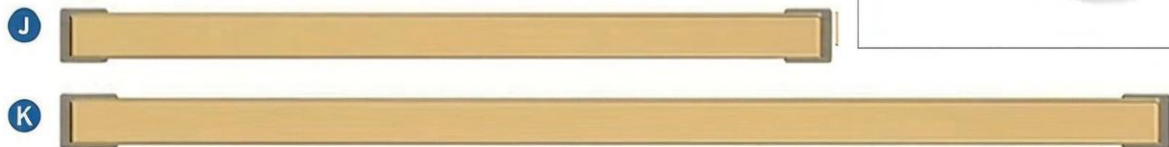

- A** 80286
1-1/4in(33mm) CTC
- 80281**
(1-1/5)*(4/5)in (31*22mm) CTC
- B** 80265
3in (76mm) CTC
- C** 80265
3-4/5in (96mm) CTC
- D** 80265
5-1/10in (128mm) CTC
- E** 80265
6-2/5in (160mm) CTC
- F** 80265
7-3/5in (192mm) CTC
- G** 80265
8-9/10in (224mm) CTC
- H** 80265
10-1/5in (256mm) CTC
- I** 80265
12-1/5in (305mm) CTC
- J** 80265
Appliance Pull 12in (305mm)CTC
- K** 80265
Appliance Pull 18in (457mm)CTC

FINISH SHOW

ABB



BLK



GD



CP



FAXIONE

No.80212



Knob



Pulls

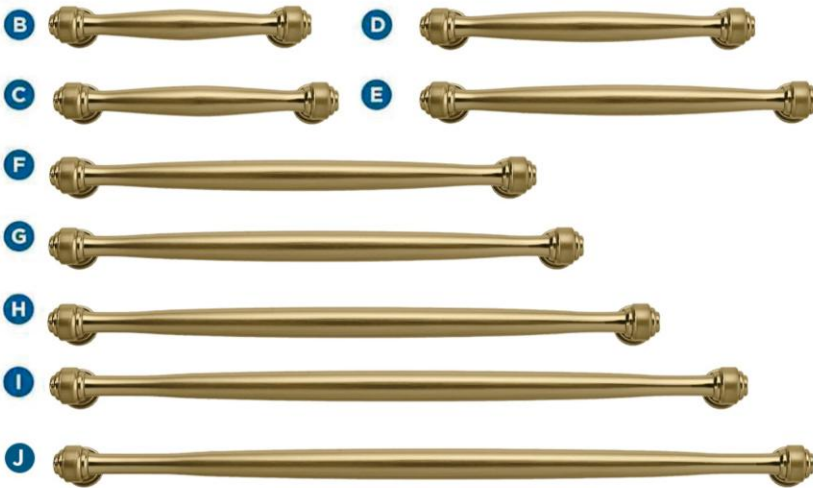

Appliance Pulls



- A** 80284
1-1/2in(38mm)CTC
- B** 80212
3in (76mm) CTC
- C** 80212
3-1/2in (89mm) CTC
- D** 80212
3-3/4in (96mm) CTC
- E** 80212
4in (102mm) CTC
- F** 80212
5in (128mm) CTC
- G** 80212
6-3/10in (160mm) CTC
- H** 80212
8in (203mm) CTC
- I** 80212
10in (256mm) CTC
- J** 80212
12in (305mm) CTC
- K** 80212
Appliance Pull 12in (305mm)CTC
- L** 80212
Appliance Pull 18in (457mm)CTC

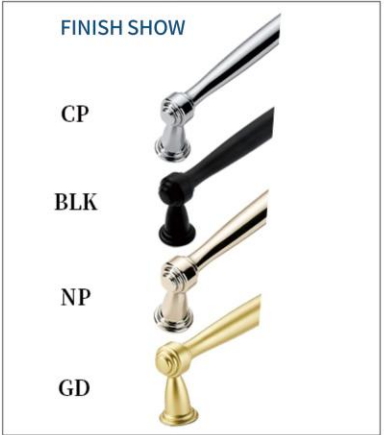

FAXIONE

No.80207



Knob

A



Pulls

B



D



C



E



F



G



H



I



J



Appliance Pulls

K



L



A 80396
1.5in(38mm)CTC

B 80207
3in (76mm) CTC

C 80207
3-1/2in (89mm) CTC

D 80207
3-3/4in (96mm) CTC

E 80207
4in (102mm) CTC

F 80207
5in (128mm) CTC

G 80207
6in (152mm) CTC

H 80207
8in (203mm) CTC

I 80207
10in (256mm) CTC

J 80207
12in (305mm) CTC

K 80207
Appliance Pull 12in (305mm)CTC

L 80207
Appliance Pull 18in (457mm)CTC

FINISH SHOW

CP



BLK



AB



NP



FAXIONE

No.80296



- A** 80296
1-7/8in(49mm)CTC
80057
1in(25mm) CTC
- B** 80296
3in (76mm) CTC
- C** 80296
3-1/2in (89mm) CTC
- D** 80296
3-3/4in (96mm) CTC
- E** 80296
4in (102mm) CTC
- F** 80296
5in (128mm) CTC
- G** 80296
6in (152mm) CTC
- H** 80296
8in (203mm) CTC
- I** 80296
10in (256mm) CTC
- J** 80296
12in (305mm) CTC
- K** 80296
Appliance Pull 12in (305mm)CTC
- L** 80296
Appliance Pull 18in (457mm)CTC

Knob



Pulls

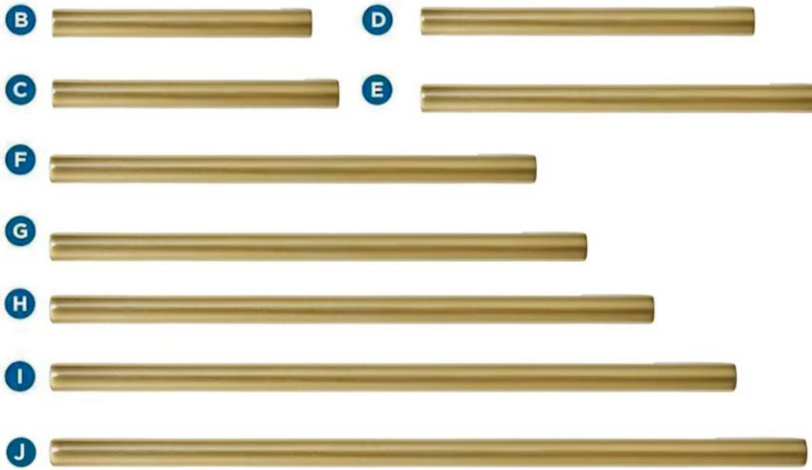

Appliance Pulls



FINISH SHOW

- CP
- BLK
- SN
- AB

FAXIONE

No.80279



Knob

A



Pulls

B



D



C



E



F



G



H



I



Appliance Pulls

K



- A** 80281
1-1/4in(32mm) CTC
- B** 80279
3in (76mm) CTC
- C** 80279
3-1/2in (89mm) CTC
- D** 80279
3-3/4in (96mm) CTC
- E** 80279
4in (102mm) CTC
- F** 80279
5in (128mm) CTC
- G** 80279
6in (152mm) CTC
- H** 80279
8in (203mm) CTC
- I** 80279
10in (256mm) CTC
- J** 80279
12in (305mm) CTC
- K** 80279
Appliance Pull 12in (305mm)CTC
- L** 80279
Appliance Pull 18in (457mm)CTC

FINISH SHOW

CP



BLK



NP



AB



FAXIONE

No.80302



Knob

A



Pulls

B



D



C



E



F



G



H



I



J



Appliance Pulls

K



L



- A** 80303
1-1/8in(28mm)CTC
- B** 80302
3in (76mm) CTC
- C** 80302
3-1/2in (89mm) CTC
- D** 80302
3-3/4in (96mm) CTC
- E** 80302
4in (102mm) CTC
- F** 80302
5in (128mm) CTC
- G** 80302
6in (152mm) CTC
- H** 80302
8in (203mm) CTC
- I** 80302
10in (256mm) CTC
- J** 80302
12in (305mm) CTC
- K** 80302
Appliance Pull 12in (305mm)CTC
- L** 80302
Appliance Pull 18in (457mm)CTC

FINISH SHOW

CP



BLK



SN



AB



FAXIONE

No.80344



Knob

A



Pulls

B



D



C



E



F



G



H



I



J



Appliance Pulls

K



L



80280

A

small: 1-1/4in(32mm)CTC
Large:1-3/4in(44mm)CTC

B

80344
3in (76mm) CTC

C

80344
3-1/2in (89mm) CTC

D

80344
3-3/4in (96mm) CTC

E

80344
4in (102mm) CTC

F

80344
5in (128mm) CTC

G

80344
6in (152mm) CTC

H

80344
8in (203mm) CTC

I

80344
10in (256mm) CTC

J

80344
12in (305mm) CTC

K

80344
Appliance Pull 12in (305mm)CTC

L

80344
Appliance Pull 18in (457mm)CTC

FINISH SHOW

CP



BLK



SN



AB



FAXIONE

No.80345



- A** 80270
1-1/4in(32mm) CTC
- B** 80345
3in (76mm) CTC
- C** 80345
3-1/2in (89mm) CTC
- D** 80345
3-3/4in (96mm) CTC
- E** 80345
4in (102mm) CTC
- F** 80345
5in (128mm) CTC
- G** 80345
6in (152mm) CTC
- H** 80345
8in (203mm) CTC
- I** 80345
10in (256mm) CTC
- J** 80345
12in (305mm) CTC
- K** 80345
Appliance Pull 12in (305mm)CTC
- L** 80345
Appliance Pull 18in (457mm)CTC

Knob



Pulls



Appliance Pulls



FINISH SHOW

- CP
- BLK
- NP
- GD

FAXIONE

No.80309



Knob



Pulls



Appliance Pulls



- A** 80310
1in(25mm) CTC
- B** 80309
3in (76mm) CTC
- C** 80309
3-1/2in (89mm) CTC
- D** 80309
3-3/4in (96mm) CTC
- E** 80309
4in (102mm) CTC
- F** 80309
5in (128mm) CTC
- G** 80309
6in (152mm) CTC
- H** 80309
8in (203mm) CTC
- I** 80309
10in (256mm) CTC
- J** 80309
12in (305mm) CTC
- K** 80309
Appliance Pull 12in (305mm)CTC
- L** 80309
Appliance Pull 18in (457mm)CTC

FINISH SHOW

SN



BLK



NP



GD



FAXIONE

No.80297



- A** 80320
1-1/2in (30mm) CTC
- B** 80297
3in (76mm) CTC
- C** 80297
3-1/2in (89mm) CTC
- D** 80297
3-3/4in (96mm) CTC
- E** 80297
4in (102mm) CTC
- F** 80297
5in (128mm) CTC
- G** 80297
6in (152mm) CTC
- H** 80297
8in (203mm) CTC
- I** 80297
10in (256mm) CTC
- J** 80297
12in (305mm) CTC
- K** 80297
Appliance Pull 12in (305mm)CTC
- L** 80297
Appliance Pull 18in (457mm)CTC

Knob



Pulls

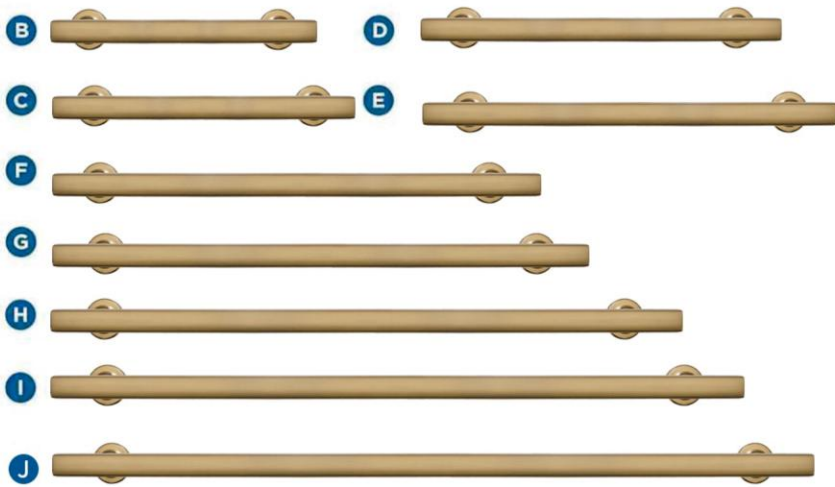

Appliance Pulls



FINISH SHOW

- CP
- BLK
- NP
- AB

FAXIONE

No.80346



Knob

A



Pulls

B



D



C



E



F



G



H



I



Appliance Pulls

J



K



A 80443
1-1/8in(29mm)CTC

B 80346
3in (76mm) CTC

C 80346
3-1/2in (89mm) CTC

D 80346
3-3/4in (96mm) CTC

E 80346
4in (102mm) CTC

F 80346
5in (128mm) CTC

G 80346
6in (152mm) CTC

H 80346
8in (203mm) CTC

I 80346
10in (256mm) CTC

J 80346
12in (305mm) CTC

K 80346
Appliance Pull 12in (305mm)CTC

L 80346
Appliance Pull 18in (457mm)CTC

FINISH SHOW

CB



BLK



NP



GD



FAXIONE

No.80347



- A** 80347
2in (50mm) CTC
80057
1 (25mm) CTC
- B** 80347
3in (76mm) CTC
- C** 80347
3-1/2in (89mm) CTC
- D** 80347
3-3/4in (96mm) CTC
- E** 80347
4in (102mm) CTC
- F** 80347
5in (128mm) CTC
- G** 80347
6in (152mm) CTC
- H** 80347
8in (203mm) CTC
- I** 80347
10in (256mm) CTC
- J** 80347
12in (305mm) CTC
- K** 80347
Appliance Pull 12in (305mm)CTC
- L** 80347
Appliance Pull 18in (457mm)CTC

Knob



Pulls

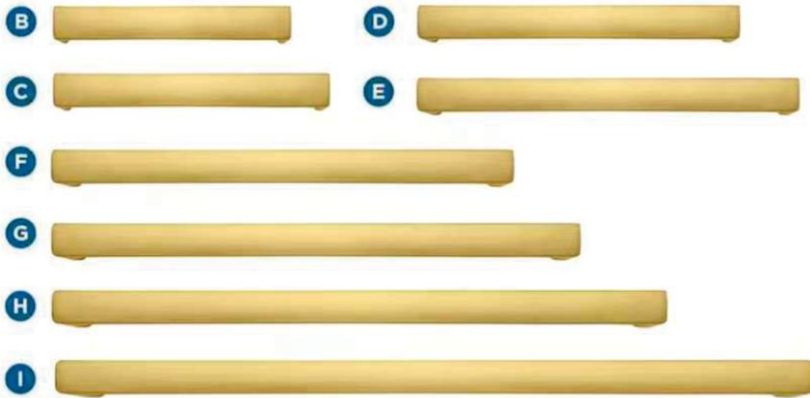

Appliance Pulls

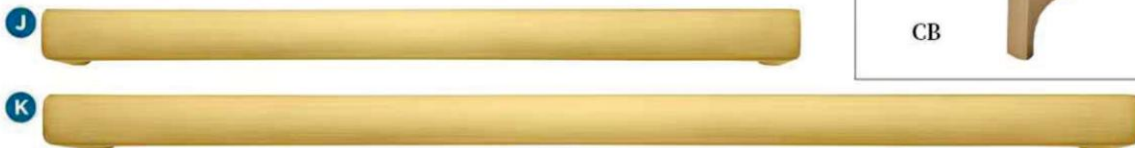

FINISH SHOW

CP

BLK

NP

CB



FAXIONE

No.80297



Knob



Pulls

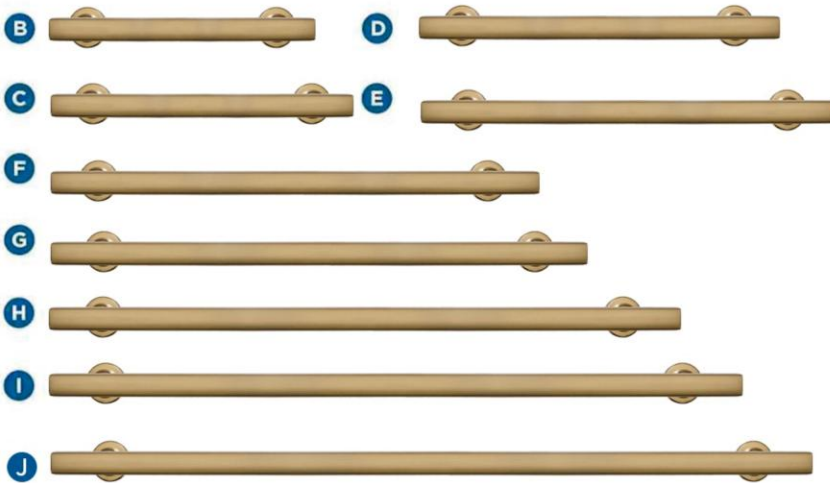

Appliance Pulls



- A** 80320
1-1/2in (30mm) CTC
80351
2in(20mm)CTC
- B** 80297
3in (76mm) CTC
- C** 80297
3-1/2in (89mm) CTC
- D** 80297
3-3/4in (96mm) CTC
- E** 80297
4in (102mm) CTC
- F** 80297
5in (128mm) CTC
- G** 80297
6in (152mm) CTC
- H** 80297
8in (203mm) CTC
- I** 80297
10in (256mm) CTC
- J** 80297
12in (305mm) CTC
- K** 80297
Appliance Pull 12in (305mm)CTC
- L** 80297
Appliance Pull 18in (457mm)CTC

FINISH SHOW

CP



BLK



NP



AB



FAXIONE

No.80324



- A** 80325
1-1/8in(29mm)CTC
- B** 80324
3in(76mm)CTC
- C** 80324
3-1/2in(89mm)CTC
- D** 80324
3-3/4in(96mm)CTC
- E** 80324
4in(102mm)CTC
- F** 80324
5in(128mm)CTC
- G** 80324
6in(152mm)CTC
- H** 80324
8in(203mm)CTC
- I** 80324
10in(256mm)CTC
- J** 80324
12in(305mm)CTC
- K** 80324
18in(457mm)CTC

Knob



Pulls

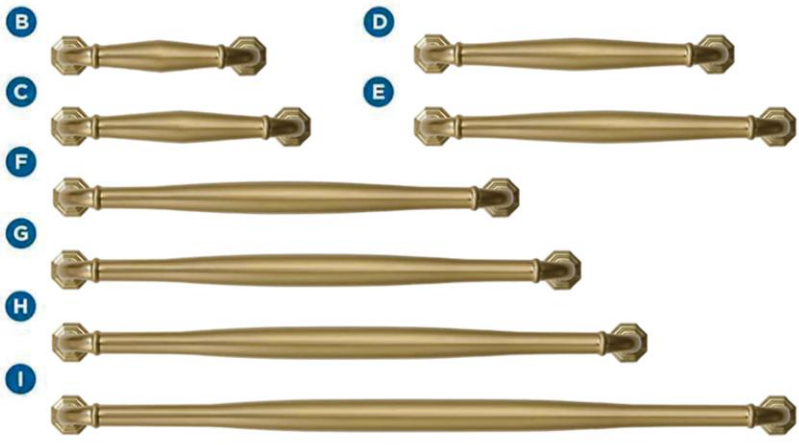

Appliance Pulls



FINISH SHOW

- SN** 
- BLK** 
- PB** 
- NP** 

FAXIONE

No.80348



Knob



Pulls

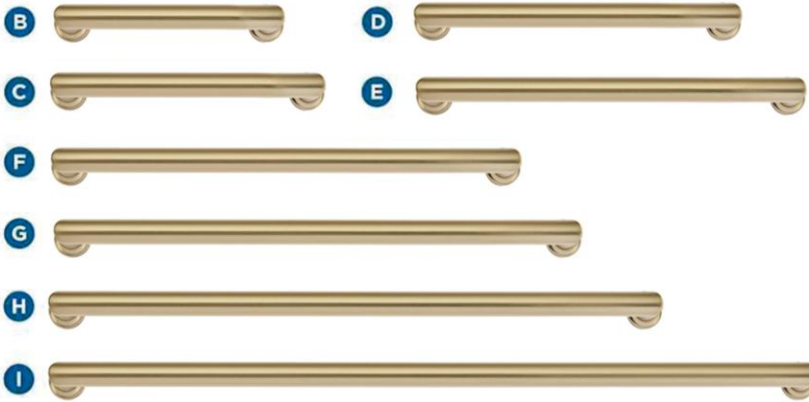

Appliance Pulls



- A** 88285
1in(28mm) CTC
- B** 80348
3in (76mm) CTC
- C** 80348
3-1/2in (89mm) CTC
- D** 80348
3-3/4in (96mm) CTC
- E** 80348
4in (102mm) CTC
- F** 80348
5in (128mm) CTC
- G** 80348
6in (152mm) CTC
- H** 80348
8in (203mm) CTC
- I** 80348
10in (256mm) CTC
- J** 80348
12in (305mm) CTC
- K** 80348
Appliance Pull 12in (305mm)CTC
- L** 80348
Appliance Pull 18in (457mm)CTC

FINISH SHOW

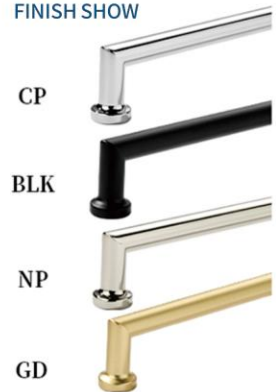

FAXIONE

No.80340



Knob



Pulls

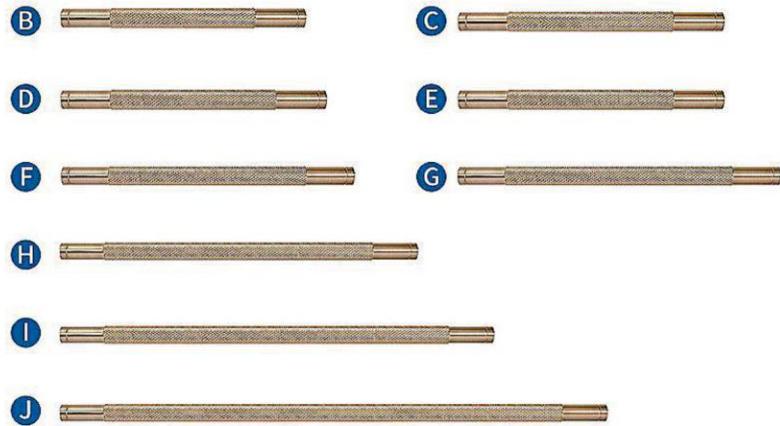

Appliance Pulls

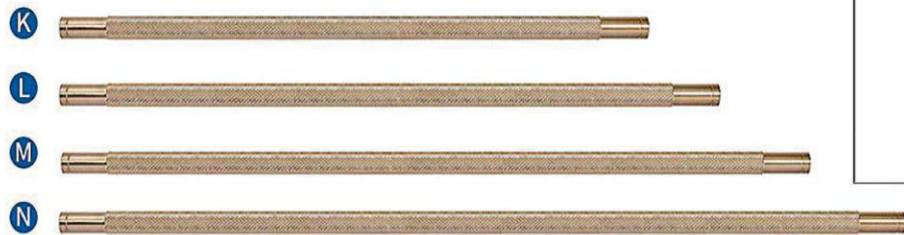

- A** 80341
2in(50mm) CTC
- B** 80340
3in (76mm) CTC
- C** 80340
3-1/2in (89mm) CTC
- D** 80340
3-3/4in (96mm) CTC
- E** 80340
4in (102mm) CTC
- F** 80340
5in (128mm) CTC
- G** 80340
6in (152mm) CTC
- H** 80340
8in (203mm) CTC
- I** 80340
10in (256mm) CTC
- J** 80340
12in (305mm) CTC
- K** 80340
Appliance Pull 12in (305mm) CTC
- L** 80340
Appliance Pull 15in (381mm) CTC
- M** 80340
Appliance Pull 18in (457mm) CTC
- N** 80340
Appliance Pull 24in (610mm) CTC

FINISH SHOW



FAXIONE

No.80299



Knob



Pulls

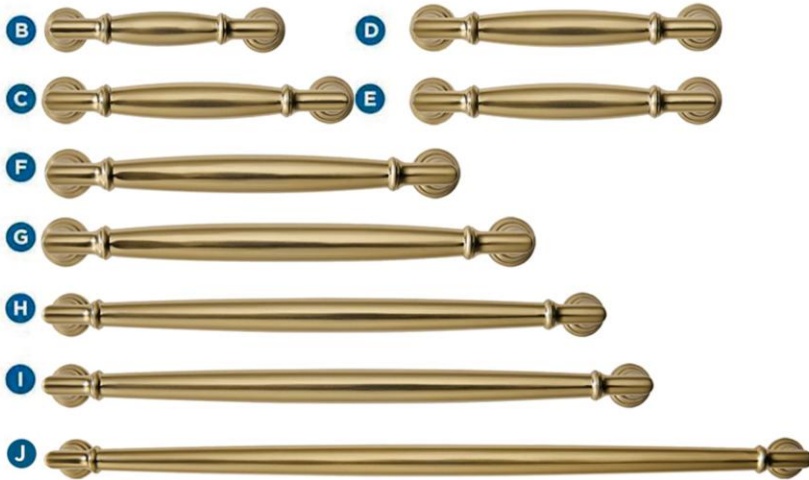

Appliance Pulls



- A** 80306
1-1/4in(30mm)CTC
- B** 80299
3in (76mm) CTC
- C** 80299
3-1/2in (89mm) CTC
- D** 80299
3-3/4in (96mm) CTC
- E** 80299
4in (102mm) CTC
- F** 80299
5in (128mm) CTC
- G** 80299
6in (152mm) CTC
- H** 80299
8in (203mm) CTC
- I** 80299
10in (256mm) CTC
- J** 80299
12in (305mm) CTC
- K** 80299
Appliance Pull 12in (305mm)CTC
- L** 80299
Appliance Pull 18in (457mm)CTC

FINISH SHOW



FAXIONE

No.80338



Knob



Pulls

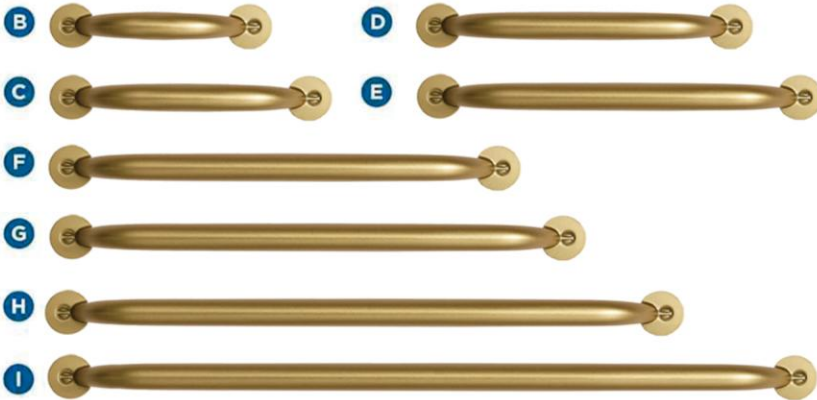

Appliance Pulls



- A** 80057
1in(25mm) CTC
- B** 80338
3in (76mm) CTC
- C** 80338
3-1/2in (89mm) CTC
- D** 80338
3-3/4in (96mm) CTC
- E** 80338
4in (102mm) CTC
- F** 80338
5in (128mm) CTC
- G** 80338
6in (152mm) CTC
- H** 80338
8in (203mm) CTC
- I** 80338
10in (256mm) CTC
- J** 80338
12in (305mm) CTC
- K** 80338
Appliance Pull 12in (305mm)CTC
- L** 80338
Appliance Pull 18in (457mm)CTC



FAXIONE

No.80362



Knob

A



Pulls

B



D



C



E



F



G



H



I



J



Appliance Pulls

K



L



A 80310

1in(25mm) CTC

B 80362

3in (76mm) CTC

C 80362

3-1/2in (89mm) CTC

D 80362

3-3/4in (96mm) CTC

E 80362

4in (102mm) CTC

F 80362

5in (128mm) CTC

G 80362

6in (152mm) CTC

H 80362

8in (203mm) CTC

I 80362

10in (256mm) CTC

J 80362

12in (305mm) CTC

K 80362

Appliance Pull 12in (305mm)CTC

L 80362

Appliance Pull 18in (457mm)CTC

FINISH SHOW

CP



BLK



NP



CB



FAXIONE

No.80880



Knob

A



Pulls

B



D



C



E



F



G



H



I



Appliance Pulls

J



K



A 80027

1-1/4 in(32mm)CTC

B 80880

3in(76mm)CTC

C 80880

3-1/2in(89mm)CTC

D 80880

3-3/4in(96mm)CTC

E 80880

4in(102mm)CTC

F 80880

5in(128mm)CTC

G 80880

6in(152mm)CTC

H 80880

8in(203mm)CTC

I 80880

10in(256mm)CTC

J 80880

Appliance Pull 12in (305mm)CTC

K 80880

Appliance Pull 18in (457mm)CTC

FINISH SHOW

BSN



BLK



PB



NP



FAXIONE

No.80374



Knob



Pulls

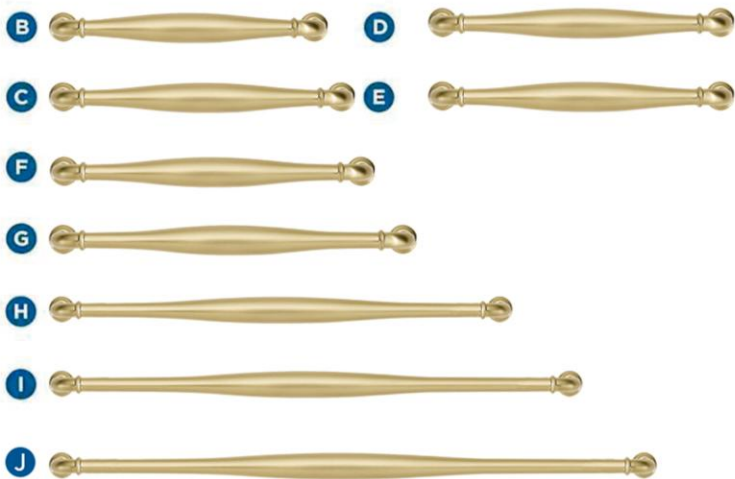

Appliance Pulls



- A** 80413
1-2/7inch(32mm)CTC
- B** 80374
3inch(76mm)CTC
- C** 80374
3-1/2inch(89mm)CTC
- D** 80374
3-3/4inch(96mm)CTC
- E** 80374
4inch(102mm)CTC
- F** 80374
5inch(128mm)CTC
- G** 80374
6inch(152mm)CTC
- H** 80374
8inch(203mm)CTC
- I** 80374
10inch(256mm)CTC
- J** 80374
12in (305mm) CTC
- K** 80374
Appliance Pull 12in (305mm)CTC
- L** 80374
Appliance Pull 18in (457mm)CTC

FINISH SHOW



FAXIONE

No.80419



Knob



Pulls



Appliance Pulls



- A** 80303
1-1/4in(28mm)CTC
- B** 80419
3inch(76mm)CTC
- C** 80419
3-1/2inch(89mm)CTC
- D** 80419
3-3/4inch(96mm)CTC
- E** 80419
4inch(102mm)CTC
- F** 80419
5inch(128mm)CTC
- G** 80419
6inch(152mm)CTC
- H** 80419
8inch(203mm)CTC
- I** 80419
10inch(256mm)CTC
- J** 80419
12inch(305mm)CTC
- K** 80419
Appliance Pull 12in (305mm)CTC
- L** 80419
Appliance Pull 18in (457mm)CTC

FINISH SHOW

CP



BLK



AB



SN



FAXIONE

No.80375



Knob



Pulls

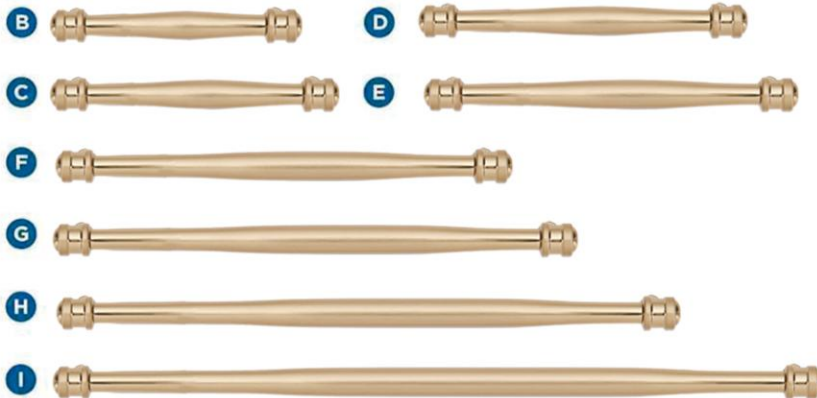

Appliance Pulls



- A** 80306
1-1/4inch(30mm)CTC
- B** 80375
3in (76mm) CTC
- C** 80375
3-1/2in (89mm) CTC
- D** 80375
3-3/4in (96mm) CTC
- E** 80375
4in (102mm) CTC
- F** 80375
5in (128mm) CTC
- G** 80375
6in (152mm) CTC
- H** 80375
8in (203mm) CTC
- I** 80375
10in (256mm) CTC
- J** 80375
12in (305mm) CTC
- K** 80375
Appliance Pull 12in (305mm)CTC
- L** 80375
Appliance Pull 18in (457mm)CTC

FINISH SHOW



FAXIONE

No.80414



Knob



Pulls

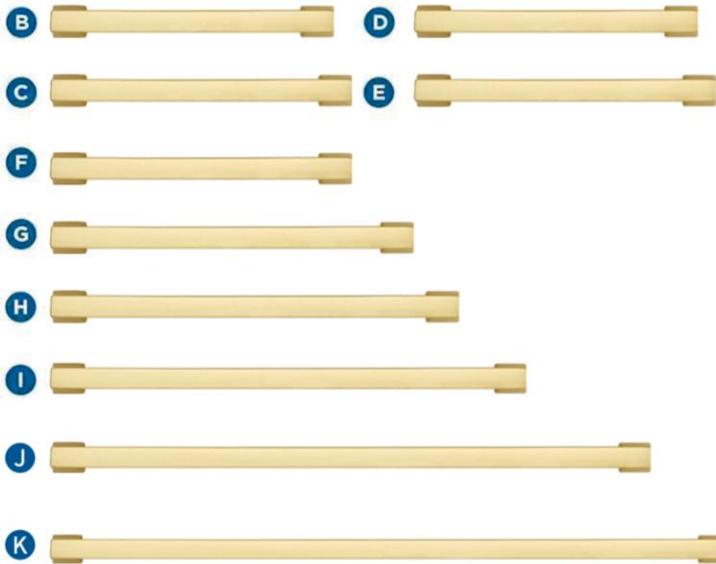

Appliance Pulls



- A** 80320
1-2/7inch(32.3mm)Diameter
- B** 80414
3inch(76mm)CTC
- C** 80414
3-1/4inch(82mm)CTC
- D** 80414
3-1/2inch(89mm)CTC
- E** 80414
3-3/4inch(96mm)CTC
- F** 80414
4inch(102mm)CTC
- G** 80414
5inch(128mm)CTC
- H** 80414
6inch(152mm)CTC
- I** 80414
8inch(203mm)CTC
- J** 80414
10inch(256mm)CTC
- K** 80414
12inch(305mm)CTC
- L** 80266
Appliance Pull 12in (305mm)CTC
- M** 80266
Appliance Pull 18in (457mm)CTC

FINISH SHOW

CP



BLK



AB



SN



FAXIONE

No.80038



Knob

A



Pulls

B



C

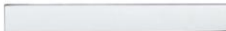

D



E



F

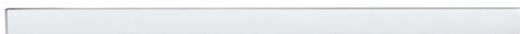

G



H

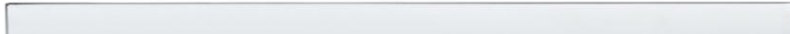

I

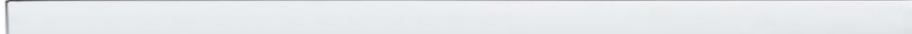

- A** 80215
1-1/4 in(32mm)CTC
- B** 80038
3-3/4in (96mm) CTC
- C** 80038
5in (128mm) CTC
- D** 80038
6-1/4in (160mm) CTC
- E** 80038
7-1/2in (192mm) CTC
- F** 80038
8-3/4in (224mm) CTC
- G** 80038
10in (256mm) CTC
- H** 80038
11-1/4in (288mm) CTC
- I** 80038
12-1/2in (320mm) CTC

FINISH SHOW

CP



BLK



NP



SN



FAXIONE

No.80267



- A** 80095
3/5 in (40mm) CTC
- B** 80267
2-1/2 in (64mm) CTC
- C** 80267
3 in (76mm) CTC
- D** 80267
3-1/2 in (89mm) CTC
- E** 80267
3-7/10 in (96mm) CTC
- F** 80267
4 in (102mm) CTC
- G** 80267
5 in (128mm) CTC
- H** 80267
6-3/10 in (160mm) CTC
- I** 80267
7-1/5 in (192mm) CTC
- J** 80267
8-4/5 in (224mm) CTC
- K** 80267
10-1/10 in (256mm) CTC
- L** 80267
12 in (305mm) CTC
- M** 80267
12-3/5 in (320mm) CTC

Knob



Pulls

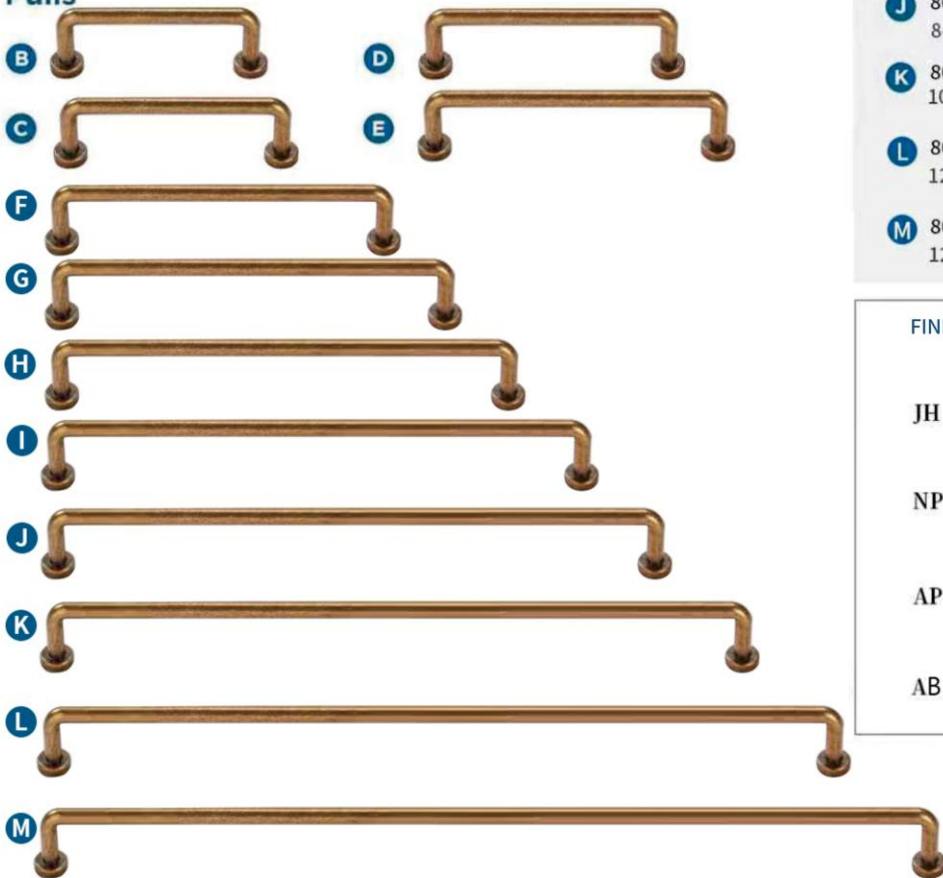

FINISH SHOW

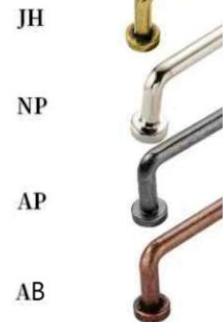

FAXIONE

No.80273



Knob

A



Pulls

B



C



D



E



F



G



H



A 80300
1-1/4in(32mm) CTC

B 80273
3in (76mm) CTC

C 80273
3-7/10in (96mm) CTC

D 80273
5in (128mm) CTC

E 80273
6in (152mm) CTC

F 80273
8in (203mm) CTC

G 80273
12in (305mm) CTC

H 80273
12-3/5in (320mm) CTC

FINISH SHOW

AC



BLK



AB



RI



FAXIONE

No.80263



- A** 80057
1 in(25mm) CTC
- B** 80263
2.5in (64mm) CTC
- C** 80263
3in (76mm) CTC
- D** 80263
3.5in (89mm) CTC
- E** 80263
3.7in (96mm) CTC
- F** 80263
4in (102mm) CTC
- G** 80263
5in (128mm) CTC
- H** 80263
7in (178mm) CTC

Knob



Pulls



FINISH SHOW



FAXIONE

No.80357



Knob



Pulls



- A** 88285
1in(28mm) CTC
- B** 80357
2-1/2in (64mm) CTC
- C** 80357
3in (76mm) CTC
- D** 80357
3-1/2in (89mm) CTC
- E** 80357
3-3/4in (96mm) CTC
- F** 80357
5in (128mm) CTC
- G** 80357
6in (152mm) CTC
- H** 80357
7in (178mm) CTC

FINISH SHOW

AB



BLK



SN



PB



FAXIONE Handle

80032



- 80032
3-3/4in (96mm)CTC
- 80032
5in (128mm)CTC
- 80032
6-1/4in (160mm)CTC
- 80032
7-1/2in (192mm)CTC
- 80032
10in (256mm)CTC
- 80032
12-1/2in (320mm)CTC

FAXIONE Shell

80003



- 80003
2-1/2in (64mm) CTC
- 80003
3in (76mm) CTC
- 80003
3-1/2in (89mm) CTC
- 80003
3-3/4in (96mm) CTC
- 80003
4in (102mm) CTC
- 80003
5in (128mm) CTC

FAXIONE

Handle

80102



Size

3-3/4in(96mm)
5in(128mm)
6-1/4in(160mm)
7-1/2in(192mm)
11-1/3in(288mm)

80187



Size

3-3/4in(96mm)
5in(128mm)
6-1/4in(160mm)

80264



Size

3in(76mm)
3-3/4in(96mm)
5in(128mm)
6-1/4in(160mm)
7-1/2in(192mm)
10in(256mm)

80147



Size

3-3/4in(96mm)
5in(128mm)

FAXIONE

Handle

80317



Size

Plate: 3.8*1.2in (95*29mm)

H: 1.4in (35mm)

80311



Size

Plate: 2*1.5in (52*40mm)

H: 1in (26mm)

80308



Size

Plate: 1.5*1.5in (40*40mm)

H: 0.9in (25mm)

80307



Size

Plate: 2.6*1.2in (66*30mm)

H: 1in (26mm)

80316



Size

Plate: 1.38*1.38in (35*35mm)

H: 1.38in (35mm)

FAXIONE

Backplate



80288

L=4in(102mm)

W=1in(25mm)



80289-KX

3in (76mm) 3-1/2in (89mm)

3-3/4in (96mm) 4in (102mm)

5in (128mm) 6in (152mm)

8in (203mm) 10in (256mm)

12in (305mm)



80289-SX

3in (76mm) 3-1/2in (89mm)

3-3/4in (96mm) 4in (102mm)

5in (128mm) 6in (152mm)

8in (203mm) 10in (256mm)

12in (305mm)



80368

3in (76mm) 3-1/2in (89mm)

3-3/4in (96mm) 4in (102mm)

5in (128mm) 6in (152mm)

8in (203mm) 10in (256mm)

12in (305mm)



80371

3in (76mm) 3-1/2in (89mm)

3-3/4in (96mm) 4in (102mm)

5in (128mm) 6in (152mm)

8in (203mm) 10in (256mm)

12in (305mm)

A BLK



B CP



C SN



D ORB





Backplate

80423



Size

Dia: 1.3*1.3in(32*32mm)
1.5*1.5in(38*38mm)
2.3*2.3in(58*58mm)

80305



Size

Dia: 2.3*2.3in
(58*58mm)

80431



Size

Dia: 1.55*1.55in
(39*39mm)

80353



Size

Dia: 2.7*0.9in
(68*24mm)



Backplate



80355

2-3/8in(55mm)



80323

1-1/2*1-1/2in
(38*38mm)



80287

2-4/5*1*1/4in
(71*25*6mm)



80304

1-1/2in(38mm)

A BLK



B CP



C PN



D ORB



FAXIONE

Handle



80471

Size

3-3/4in(96mm)

5in(128mm)



80472

Size

3-3/4in(96mm)

5in(128mm)



80473

Size

3-3/4in(96mm)

5in(128mm)



80474

Size

3-3/4in(96mm)

5in(128mm)

FAXIONE

Handle



80275

Size

3-3/4in(96mm)

5in(128mm)

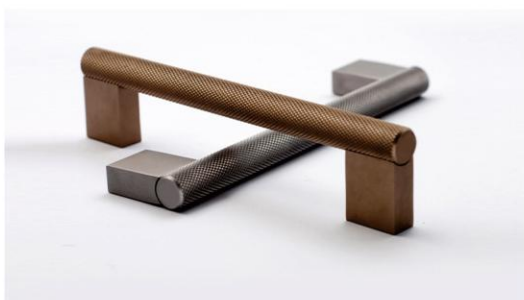

89001

Size

3-3/4in(96mm)

5in(128mm)



80262

Size

3-3/4in(96mm)

5in(128mm)



80246

Size

3-3/4in(96mm)

5in(128mm)

FAXIONE SHELL



80354 2-1/2in (64mm) CTC	80354 3in (76mm) CTC
80354 3-1/2in (89mm) CTC	80354 3-3/4in (96mm) CTC
80354 5in (128mm) CTC	80354 6in (152mm) CTC
80354 7in (178mm) CTC	80354 12in (305mm) CTC



80277 2-1/2in (64mm) CTC	80277 3in (76mm) CTC
80277 3-1/2in (89mm) CTC	80277 3-3/4in (96mm) CTC
80277 5in (128mm) CTC	80277 6in (152mm) CTC
80277 7in (178mm) CTC	80277 12in (305mm) CTC



80271 2-1/2in (64mm) CTC	80271 3in (76mm) CTC
80271 3-1/2in (89mm) CTC	80271 3-3/4in (96mm) CTC
80271 5in (128mm) CTC	80271 6in (152mm) CTC
80271 7in (178mm) CTC	80271 12in (305mm) CTC



80292 2-1/2in (64mm) CTC	80292 3in (76mm) CTC
80292 3-1/2in (89mm) CTC	80292 3-3/4in (96mm) CTC
80292 5in (128mm) CTC	80292 6in (152mm) CTC
80292 7in (178mm) CTC	80292 12in (305mm) CTC



80002 2-1/2in (64mm) CTC	80002 3in (76mm) CTC
80002 3-1/2in (89mm) CTC	80002 3-3/4in (96mm) CTC
80002 5in (128mm) CTC	80002 6in (152mm) CTC
80002 7in (178mm) CTC	80002 12in (305mm) CTC

A AB

B CB



C BLK

D GD



E SN

F ORB



G PB

B AC



FAXIONE

Knob

88285



Size

Dia: 0.7in (17mm)

H: 1.2in (30mm)

Dia: 1in (28mm)

H: 1.37in (35mm)

Dia: 1.25in (31mm)

H: 1.5in (38mm)

80270



Size

Dia: 1.25in(32mm)

H: 1.1in(28mm)

80113



Size

Dia: 1.25in(32mm)

H: 1.1in(28mm)

80095



Size

Dia: 1.6in(40mm)

H: 1in(25mm)

FAXIONE

Knob

80025



Size

Dia: 1.5in(36mm)

H: 0.8in(22mm)

80274



Size

Dia: 1.25in(32mm)

H: 1.1in(29mm)

80282



Size

Dia: 1.1in(28mm)

H: 1.1in(28mm)

80015



Size

Dia: 1.49in(38mm)

H: 0.78in(20mm)

FAXIONE

Knob

80298



Size

Dia: 1.69in(43mm)

H: 1.38in(35mm)

80301



Size

Dia: 1.5in(38mm)

H: 1in(25mm)

80281



Size

Dia: 1.2in(31mm)

H: 0.8in(22mm)

80295



Size

Dia: 1.2in(30mm)

H: 1in(25mm)

FAXIONE

Knob

80215



Size

Dia: 1.3*1.3in(32*32mm)

H: 1.2in(31mm)

80214



Size

Dia: 1.7*1.7in(44*44mm)

H: 1.3in(32mm)

80089



Size

Dia: 1.5in(37mm)

H: 1in(25mm)

80310



Size

Dia: 1in(25mm)

H: 1.5in(38mm)

FAXIONE

Knob

80157



Size

Dia: 1.37in(35mm)

H: 1.11in(28mm)

80396



Size

Dia: 1.5in(38mm)

H: 1.2in(31mm)

80024



Size

Dia: 1.37in(35mm)

H: 1.5in(38mm)

80133



Size

Dia: 1.25in(31mm)

H: 1.12in(28mm)

FAXIONE

Knob

80341



Size

Dia: 2in(50mm)

H: 1.2in(30mm)

80027



Size

Dia: 1.25in(32mm)

H: 1.1in(28mm)

80264



Size

Dia: 1.3in(33mm)

H: 1.1in(28mm)

80306



Size

Dia: 1.2in(30mm)

H: 1in(26mm)

FAXIONE

Knob

80150



Size

Dia: 1.3in(33mm)

H: 0.6in(16mm)

80092



Size

Dia: 0.8in(21mm)

H: 0.9in(22mm)

80420



Size

Dia: 1.6in(41mm)

H: 0.9in(23mm)

80241



Size

Dia: 1.4in(36mm)

H: 0.5in(14mm)

FAXIONE

Knob

80426



Size

Dia: 1-2/5in(37mm)

H: 1in(27mm)

80424



Size

Dia: 1-2/5in(37mm)

H: 1in(27mm)

80427



Size

Dia: 1-2/5in(37mm)

H: 1in(27mm)

80425



Size

Dia: 1-2/5in(37mm)

H: 1in(27mm)

80434



Size

Dia: 4in(105mm)

H: 1in(25mm)

FAXIONE

HOOK



80276

2.8*1.8*13.5in
(72*46.5*111mm)



80314

2.8*1.8*13.5in
(72*46.5*111mm)



80313

2.8*1.8*13.5in
(72*46.5*111mm)



80071

2.8*1.8*13.5in
(72*46.5*111mm)

A SN



B GD



C CP



F NP



D BLK



E ORB



G WT



H AB



FAXIONE

Handrail Stair Brackets



80350
3.3*1.45*5.51in
(84*37*140mm)



80352
2.67*1.4*4.5n
(68*36.5*115mm)



80115
1.5*1.75*2.95in
(38*45*75mm)



80111
3.25*2.57*2.97in
(81*64*74mm)

A AB



B CB



C CP



D BLK



E ORB



F SN



G WT



B PN



FAXIONE

Shelf brackets

80159



Size

- 150: 6*4*1.75in
(150*107*44mm)
- 200: 8*6*1.75in
(200*140*44mm)
- 250: 10*7*1.75in
(250*178*44mm)
- 300: 12*8*1.75in
(300*210*44mm)

80216



Size

- 125: 5*3.5*0.8in
(125*89*20mm)
- 150: 6*4*1.75in
(150*100*44mm)
- 200: 8*5.5*1.75in
(200*140*44mm)
- 250: 10*7*1.75in
(250*178*44mm)
- 300: 12*8.5*1.75in
(300*216*44mm)

80245



Size

- 5*3*1.38in
(125*76*35mm)

80326



Size

- 10*7*1.75in
(254*178*44mm)

FAXIONE

Handrail Stair Brackets



80290
2.9*2.1*2.9in
(75*54.5*73.9mm)



80291
1.77*2.13*3.15in
(44.2*53.2*78.7mm)



80312
3.5*3.1*2.2in
(89*78.7*56mm)



80322
3.25*2.57*2.97in
(81.2*64.2*74.2mm)

A AB



B CB



C CP



D BLK



E PB



F SN



G WT



FAXIONE

Door Stopper



80367

2.8*1.8*13.5in
(72*46.5*111mm)



80540

2.8*1.8*13.5in
(72*46.5*111mm)



80366

2.8*1.8*13.5in
(72*46.5*111mm)



80198

1.4*1.5in
(35*38mm)



Professional Cabinet
Hardware Manufacturer



www.faxione.com

 #1 Building 13, Xinzong Jiaowan Industrial Park,
Qiaoxia Town, Wenzhou, China

 +86-577-88801011

 info@faxione.com